

TAC 200

User's Manual

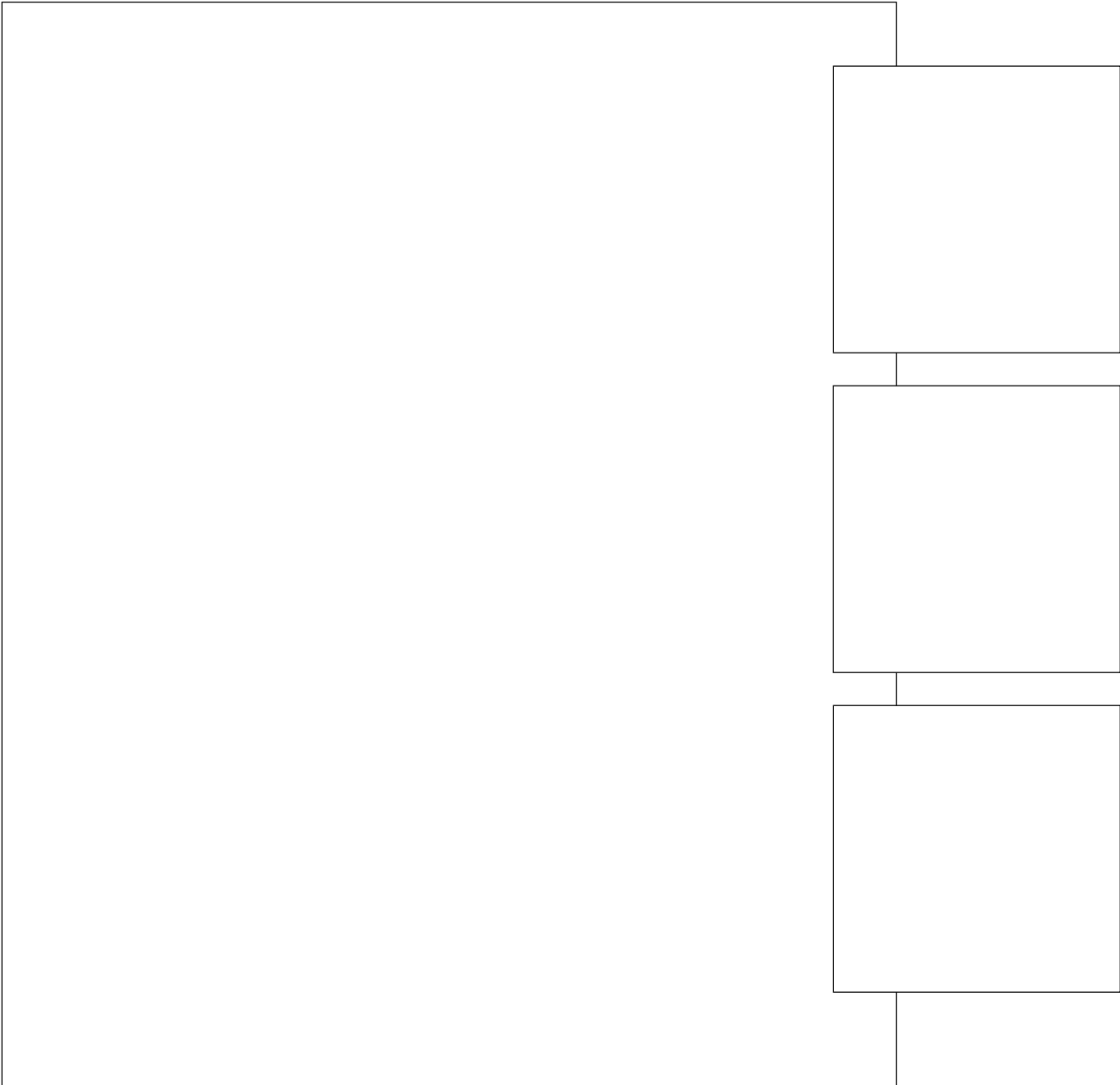

TAC 200 User's Manual

This document contains proprietary information of TAC and is made available solely to those who operate and maintain TAC equipment. Disclosure, reproduction or use of either the documents or the information contained herein for any other purpose is strictly prohibited.

TA reserves the right to make changes or additions to material as necessary.

©1993 TAC AB

Contents

1	Introduction	
1.1	The TAC 200 Heating Controller	1:1
1.2	This manual	1:1
1.3	More information	1:2
2	General	
2.1	Mounting	2:1
2.2	Connections	2:3
2.3	The Operator Panel	2:5
2.4	Commissioning	2:7
3	Daily operations, P:00 - P:15	
3.1	List of available functions	3:1
3.2	Description	3:2
4	Special functions, P:16 -	
4.1	List of available functions	4:1
4.2	Reset	4:2
4.3	Control functions	4:3
4.4	The Control Curve	4:4
4.5	Power limit function	4:6
4.5.1	Measuring the power	4:6
4.5.2	Limiting the power	4:7
4.6	Room temperature control	4:7
4.7	Night setback and Morning boost	4:9
4.8	Extended day/night operation	4:10
4.9	Time control of external units	4:11
4.10	Pump control	4:11
4.11	Time functions	4:12
4.12	Test functions	4:13

5 Technical data

5.1 Electrical	5:1
5.2 Mechanical	5:2
5.3 Default values	5:2
5.4 Part numbers	5:4

TAC 200 Commissioning protocol

Reply form

This manual contains in all 21 leaves.

1 Introduction

1.1 The TAC 200 Heating Controller

The TAC 200 is a controller for different heating systems.

TAC 200 may be operated with or without a room sensor.

It also compensates for the outdoor temperature in different ways.

The controller has an easy-to-use operator interface and needs virtually no maintenance.

1.2 This manual

This manual has the following contents.

Chapter 2

Shows how the TAC 200 is mounted, connected and commissioned. There is also a description of the operator interface with its symbols. To show the usage of the operating keys, there is a detailed description on how to set the date and time.

After the time has been set, the TAC 200 immediately starts working with default values.

Chapter 3

This chapter describes the daily operations on the TAC 200. You can read temperature values, enter setpoint values and change the time programs for day and night time operation.

Chapter 4

When a plant is commissioned and fine-tuned, it may be necessary to adjust some of the parameters. The controller function and available parameters are described in chapter 4.

Chapter 5

This is a summary of the technical data of the TAC 200. There is also a list of all the default values used at a restart.

At the end of the manual there is a commissioning protocol, where entered values should be noted.

1.3 More information

TAC 200 is also described in the following documents, available in Swedish, English and several other languages:

- **Data sheet TAC 200**

The data sheet contains a comprehensive specification of the controller and should be read together with the User's Manual.

- **List of functions in TAC 200**

A small leaflet normally placed in a slot in the operator's panel.

- **Installation instruction TAC 200**

OFL-3492-002 is a description for installation and start-up, packed together with the unit. The contents are a condensed version of chapter 2 in this manual and a graphic mounting instruction.

2 General

2.1 Mounting

Type TAC 200 controller

The TAC 200 has a plastic enclosure with a transparent cover. Install the controller in accordance with the enclosed instructions. Place the controller so that you can easily adjust and read the display.

Cable entries for cables from sensors and actuators are provided for in the mounting and terminal plate.

Type EGU outdoor sensor

Mount the sensor on an external wall facing north or northwest. The sensor should be located about 3 m above the ground and the cable entry should be oriented downwards.

Type EGWS/EGA water temperature sensors

Install the EGWS pipe sensor in the riser pipe 0.5-1 m downstream of the shunt valve. If a clamp-on sensor is fitted, mount this on an uninsulated part of the riser pipe. Carefully rub down the pipe so that the copper plate of the sensor will make good contact.

Type EGF 1 or EGRL room temperature sensors

To ensure the best possible results, observe the following when installing the room temperature sensor.

The sensor must be located in a room which is typical for the building.

The room must be sufficiently large so that no wide temperature variations will occur due to local heat sources, such as machines or occupants.

The room must not be equipped with thermostatic valves.

Locate the room sensor so that its time constant will be as short as possible. To achieve this:

- Mount the sensor on an inner wall made of lightweight building material, such as wood or plasterboard. Avoid mounting it on a concrete wall.
- Mount the sensor in an open location to ensure good circulation of air around it.
- Locate the sensor within 10 m from a radiator, but not directly above a radiator. This is particularly important in rooms without mechanical ventilation. The air velocities are then often low, which will cause a sluggish response of the control system.

Type M44, M5, M15, M42 actuators

Installation instructions for actuators are supplied together with the actuator and its installation kit.

2.2 Connections

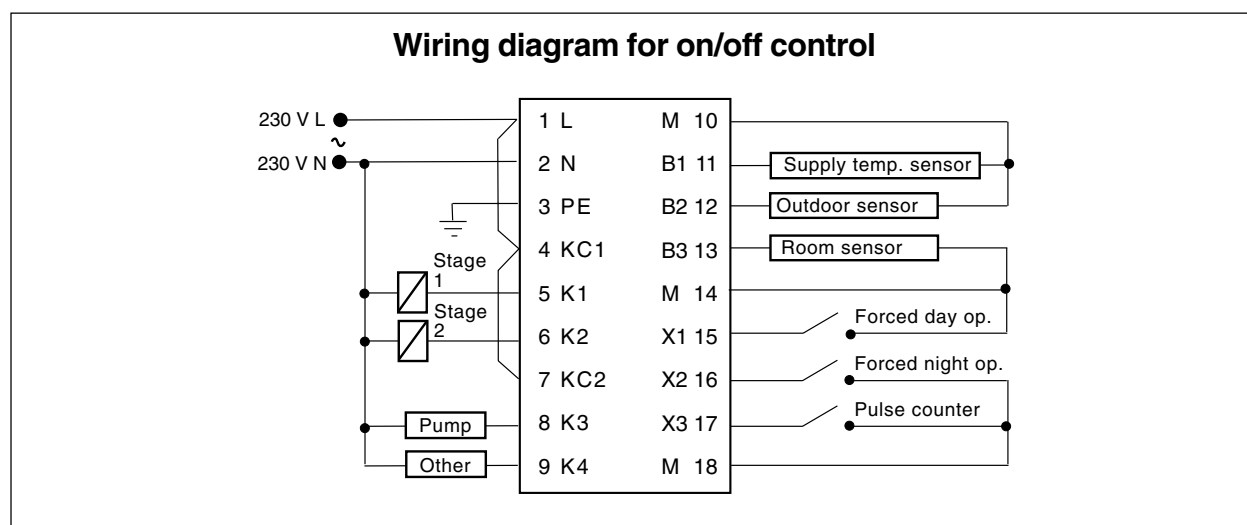
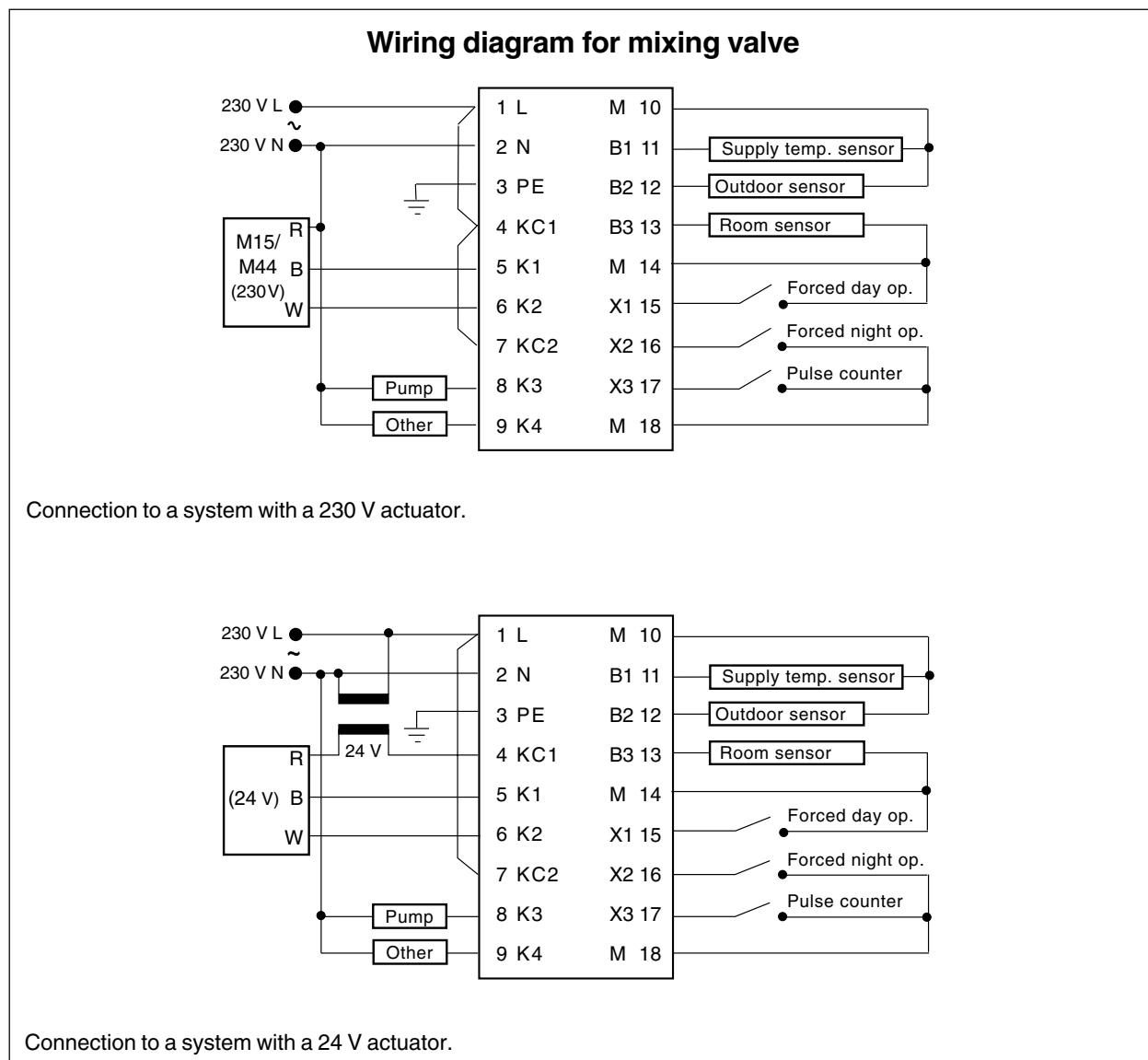

There are two types of on/off control (selected by the DIP-switch settings, see 2.4).

On/off in two steps:

	Step 1	Step 2
Stage 1	•	•
Stage 2		•

On/off in three steps:

	Step 1	Step 2	Step 3
Stage 1	•		•
Stage 2		•	•

Connections on the terminal unit.

TAC 200 has six knock-out holes for cable entries:

- 2 knock-outs in the rear part for conduit fitting Pr 18.6 (Pg 11)
- 2 knock-outs (for cables with rubber bushings) on the upper side of the case
- 2 knock-outs (for cables with rubber bushings) on the lower side of the case



High voltage cables must be kept well separated from the low voltage cables.

Connections (also any connections of 24 V to the actuators) must be performed according to the high voltage regulations.

- 1 230 V/L Supply voltage, live
- 2 230V/N Supply voltage, neutral
- 3 PE Protective earth
- 4 KC1 Voltage supply, relay K1 and K2
- 5 K1 Relay K1: increase / stage 1
- 6 K2 Relay K2: decrease / stage 2
- 7 KC2 Voltage supply, relay K3 and K4
- 8 K3 Relay K3: pump
- 9 K4 Relay K4: universal, time program 2, output
- 10 M Signal earth (Measuring ground)
- 11 B1 Supply temperature sensor, EGWS/EGA
- 12 B2 Outdoor sensor, EGU
- 13 B3 Room sensor EGRL or EGF1
(wire 1 or 2; the other, 2 or 1, to M)
- 14 M Signal earth
- 15 X1 Forced day time operation (short-circuited to M)
- 16 X2 Forced night time operation (short-circuited to M)
- 17 X3 Digital input, pulse counter
- 18 M Signal earth





Cable length

Up to 200 m, area 0.5 mm² to B1-B3 and X1-X3.

Up to 100 m, area 1.5 mm² to other terminals.

2.3 The Operator Panel

The Operator panel consists of a semi-graphic display, a leaflet with the functions and the following operating keys

-  – upward in list (in the text also called P_{up})
-  – downward in list (in the text also called p_{down})
-  – increase value
-  – decrease value
-  – toggle switch for the 30 minutes segments

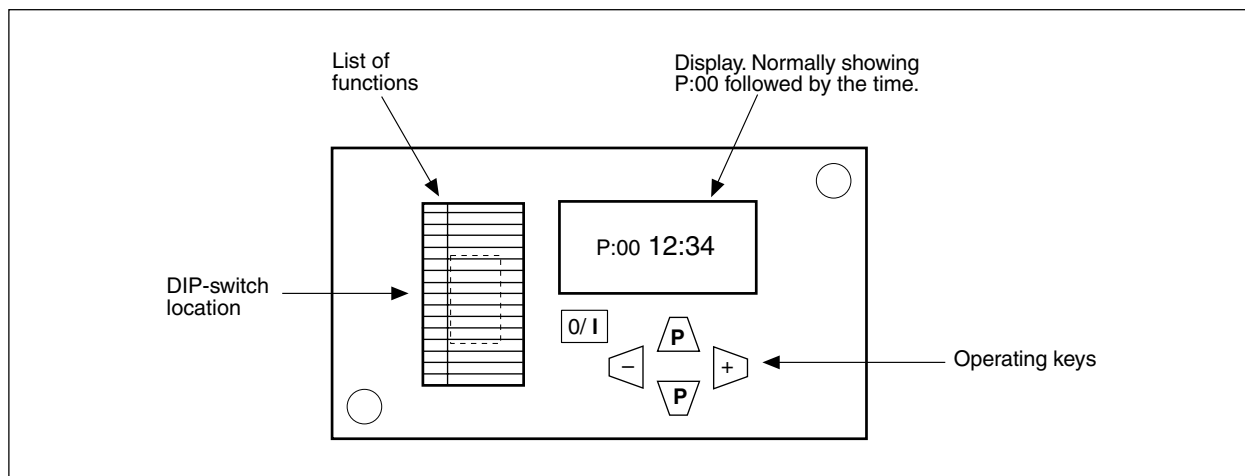

TAC 200 Operator panel.

The keys **P_{up}** and **P_{down}** are used to move up or down in the list of functions, and the keys **+** and **-** (and in some cases **0/I**) are used to change the value of the selected item.

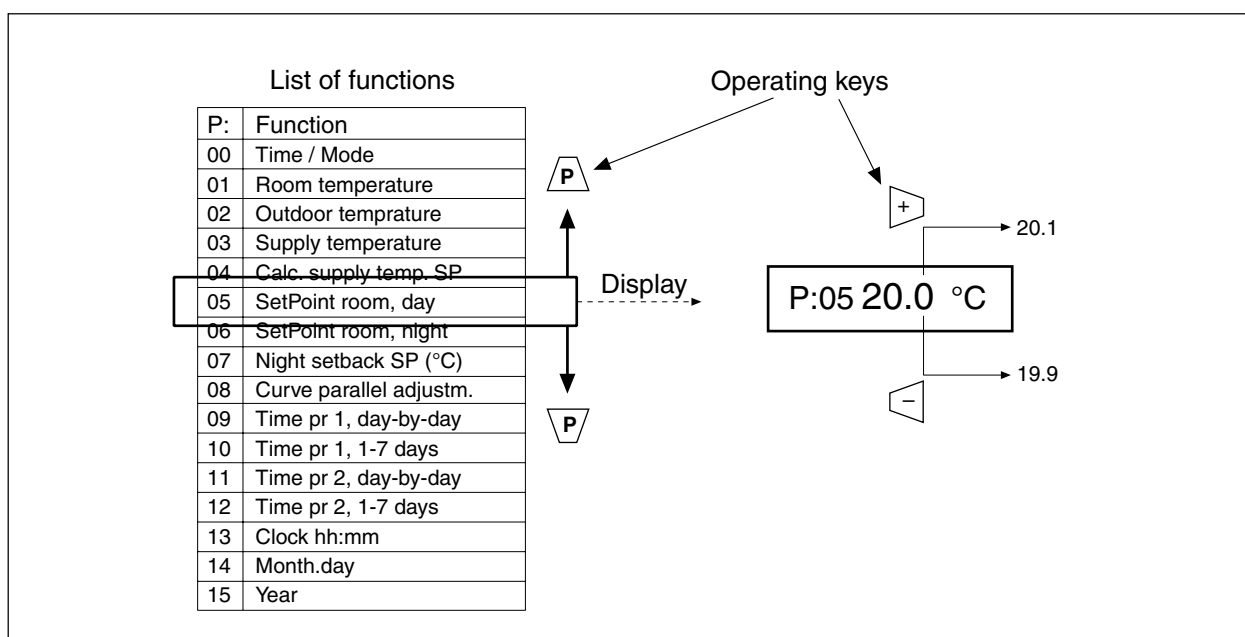

TAC 200 List of functions and example on the use of the operating keys.

If you keep pressing the + or – key, the value will change more rapidly in several levels.

If no key has been touched for about two minutes, the display will always revert to P:00, current time / operating mode.

Some of the values are display-only, for example P:02, the outdoor temperature. These P: selections are written in *italics* in the leaflet, to indicate that the displayed values cannot be changed by the operator.

Depending on the configuration of the system (section 2.4), i.e. what kind of units are connected, some of the P: functions may be *omitted* on the display.

The TAC 200 panel display has a number of letters and symbols which are used to indicate status or assist in the input.

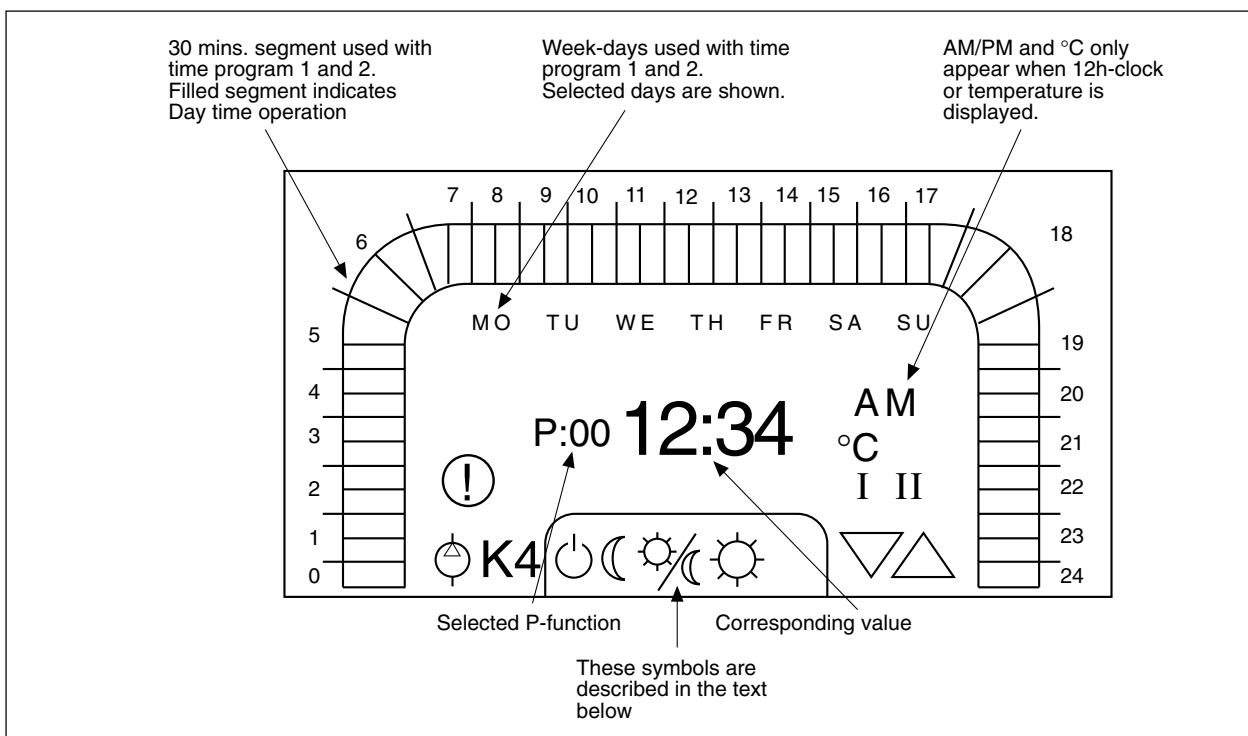

TAC 200 Operator panel.

A lighted symbol has the following meaning.

- ☉ Pump is active.
- K4 Time program 2 indicates ON.
- ⏻ Operation mode Forced Off: see section 3.2.
- ☾ Operation mode Forced Night time / flashing if forced externally.
- ☀️ Operation mode Automatic: – Time program 1 is in control.
- ☀️ Operation mode Forced Day time / flashing if forced externally
- I II On/off control: Stage 1, Stage 2 connected.
- ▽△ Mixing valve: Closing, Opening.
- ⚠️ Flashing when power limiting is active.

2.4 Commissioning

When the installation and the electric wiring have been completed, carry out the following checks and adjustments before taking the system into operation.

1. Check that the sensors and actuators have been correctly connected.
2. Locate the DIP-switches on the front panel, under the List of functions and set the switches as follows.

Switch	Position off (0)	Position on (1)
1	on/off control	mixing valve
2	on/off: 2 steps	on/off 3 steps
3	radiator heating	floor heating
4	no room sensor	room sensor
5	room sensor EGRL	room sensor EGF 1 (with SP dial)
6-7	(no significance; set to 0)	
<i>Hardware reset</i>	8	hardware reset and restart when switched from normal position 0 to 1 and back.

If switch 1 is set to 1 (mixing valve), switch 2 will have no significance.

If switch 4 is set to 0 (no sensor), switch 5 will have no significance.

If restart is needed with switch 8 the controller will not lose any set values.

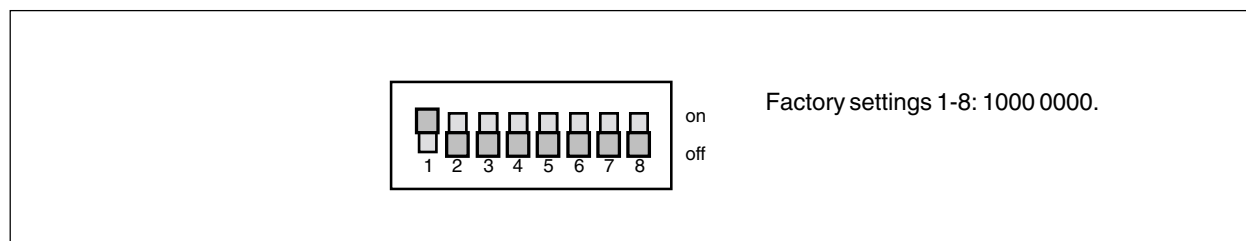



Dip-switches, underneath the list of functions

3. Connect the power supply.

4. Set the time and date:

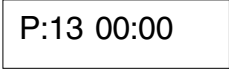
Press  till you get **P:13** Clock hh:mm





Press  or  till you get the correct time.

 (example)

(If you keep pressing the + or – key, the value will change more rapidly.)

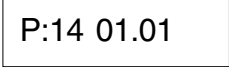
Press  to get **P:14** Month.day.





Press  or  till you get the correct date.

 (example)

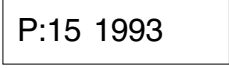

Press  to get **P:15** Year.



Press  or  till you get the correct year.

 (example)

Important

Press  or  to execute the change.

(If, by mistake, you happen to change a value and have forgotten the old value, no change will be made as long as no P-key has been pressed. In stead, wait for P:00 to re-appear, in about 2 minutes.)

5. TAC 200 is now running in auto mode, with default (factory) values. See section 5.3. Day time operation will rule 06:00 to 22:00, Monday through Sunday.

6. If other values are required, see chapters 3 and 4.

3 Daily operations, P:00 - P:15

3.1 List of available functions

The following functions are reached with the keys **P_{up}** and **P_{down}** and the corresponding values are displayed.

Values described with *italics* are display-only and cannot be changed. All other values may be changed with the keys + and –.

- P:00 *Time/Mode*
- P:01 *Room temperature*
- P:02 *Outdoor temperature*
- P:03 *Supply temperature*
- P:04 *Calculated supply temperature setpoint (SP)*
- P:05 SetPoint room, day
- P:06 SetPoint room, night
- P:07 Night setback SP (°C)
- P:08 Curve parallel adjustment
- P:09 Time program 1, day-by-day
- P:10 Time program 1, 1-7 days
- P:11 Time program 2, day-by-day
- P:12 Time program 2, 1-7 days
- P:13 Clock hh:mm
- P:14 Month.day
- P:15 Year

The operating procedures are described in section 2.3.

3.2 Description

P:00 Time / Mode

P:00 is the normal display mode and shows the current time.

In this case the + and – keys are used to shift between the different operating modes. The modes are indicated on the display. The pump freeze protection is active in all operation modes (also in Forced Off).

 Forced **Off**: – SP for supply temp. is set to 10°C.

 Forced **Night time** operation.

 **Automatic mode**, time program 1 is in control.

 Forced **Day time** operation

If Day or Night time operation has been forced from an external device (see Extended day time operation, section 4.8), the corresponding symbol will flash.

Externally forced operation (X1, X2) has a higher priority than any locally forced operation.

P:01 Room temperature (if there is a room sensor)

P:02 Outdoor temperature

P:03 Supply temperature

The selected temperature is shown in °C. The display is continuously updated, but after about 2 minutes, the display will revert to P:00 to show the time.

P:04 Calculated supply temperature setpoint

The setpoint for the supply water is calculated by the controller. The current value, in °C, is shown here.

The value cannot be changed from the display.

P:05 Setpoint room, day

P:06 Setpoint room, night

These entries are used to set the desired temperature value, when the room sensor has no setpoint dial (i.e. type EGRL). Please refer to section 4.7 for details on P:06 (and P:07).

P:07 Night setback SP

The night setback is used for the night SP if there is no room sensor at all, or when the room sensor *has* a setpoint dial (i.e. type EGF 1; the dial is normally used for the day SP).

A negative value will lead to a reduction in the temperature.

P:08 Curve parallel adjustment

The temperature curve can be adjusted upwards or downwards by the amount of degrees given. This is normally used only when there is no room sensor.

For most P: -values, for example P:00 - P:08, the current day is shown on the display, as is time program 1 on the 0-24 scale.

P:09 Time program 1, day-by-day

P:10 Time program 1, 1-7 days

P:11 Time program 2, day-by-day

P:12 Time program 2, 1-7 days

The digital clock has two time programs, TP 1 and TP 2.

TP 1 is used to switch between Day and Night time operation. TP 2 may be used for any suitable purpose.

Both can be individually set for each of the days in the week with a precision of 30 minutes. By picking suitable on/off times, operation will always occur within 15 minutes of any desired time value.

TP 1 is set by using either P:09 or P:10.

TP 2 is set by using either P:11 or P:12.

To set a time program, day-by-day:

1. Select **P:09** (TP 1) or **P:11** (TP 2).
2. Use the toggle-key (**0/I**) to
 - fill the segment for Active output
 - clear the segment for Passive output

The flashing segment will also move to the next position.

3. Move the flashing segment with the + or – keys, if necessary.
4. The day is automatically switched when you leave the last segment (or the first, backwards).
5. Enter the segments for all the days of the week.
6. To execute the changes, you *must* press either **P_{up}** or **P_{down}** when you are finished !

Important!

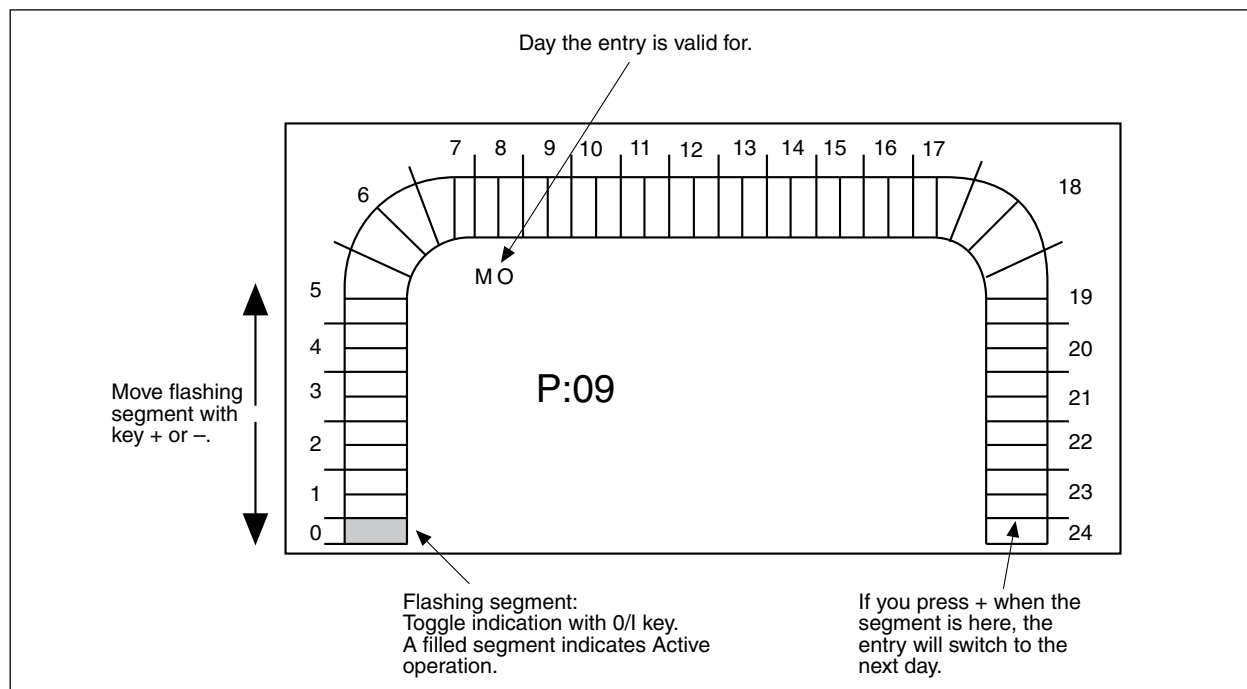

Setting a time program day-by-day.

If several days shall have the same pattern you may simplify the entry by using the following method.

Note!

This method requires some planning, as several days may be affected at the same time and as their current values are not displayed before the change. If segments under P:10 or P:12 have been changed, but you regret the changes and do not want to execute them, you must blank out *all the days* displayed, see step 2 below.

To set a time program, 1-7 days:

1. Select **P:10** (TP 1) or **P:12** (TP 2).
2. Use the toggle-key (**0/1**) and the + or – keys to set the days that shall have the new pattern, for example, Monday to Friday (no days shown → no change).
3. The flashing segment is automatically switched to the 30-minutes segments when you leave the 'Sunday' (or the 'Monday', backwards).
4. Move the flashing segment with the + or – keys and use the toggle-key (**0/1**) to
 - fill the segment for Active output
 - clear the segment for Passive output
 for all the days that were marked in step 2.

Important!

5. To execute the changes, you press either **P_{up}** or **P_{down}** !
6. Now return to P:10 or P:12 if you want to affect the other days, for example Saturday to Sunday.
7. Specify the active segments for these days as in steps 2-5.

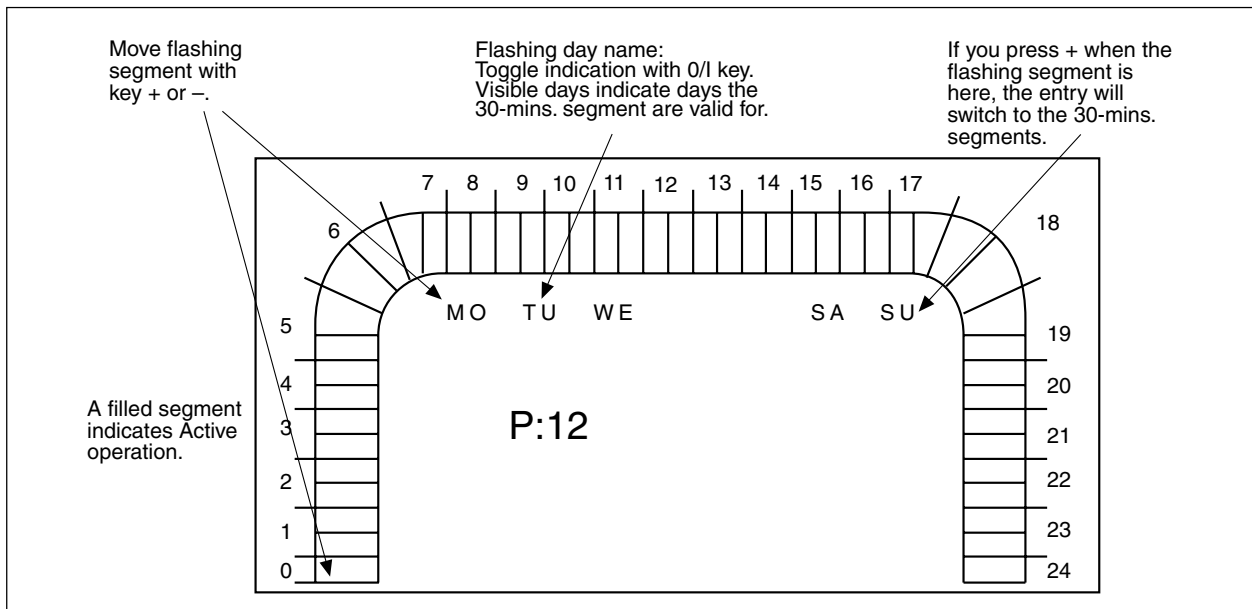

Setting a time program 1-7 days.

- P:13 Clock hh:mm**
- P:14 Month.day**
- P:15 Year**

How to set time and date is shown in section 2.4.

4 Special functions, P:16 -

4.1 List of available functions

The following functions are normally only used during commissioning or if special adjustments are required.

Values described with *italics* are display-only and cannot be changed. All other values may be changed with the keys + and -.

To reach the functions beyond P:15, you must do as follows:

Press \square **P** and \square **P** at the same time.

P:16 Max supply temperature

P:17 Min supply temperature

P:18 Curve point x(1)

P:19 Curve point y(0)

P:20 Curve point y(1)

P:21 Curve point y(2)

P:22 Wh / pulse

P:23 Pulses / kWh

P:24 SP max-power kW

P:25 *Current power kW*

P:26 Power limit control interval (minutes)

P:27 Power limit gain (°C/kW)

P:28 Power limit I-time (minutes)

P:29 Room sensor authority

P:30 Room I-time (minutes)

P:31 Room deadzone (°C)

P:32 Max. room influence, day

P:33 Max. room influence, night

P:34 Supply P-band (°C)

P:35 Supply I-time (minutes)

P:36 Actuator stroke time (seconds)

P:37 °C x min On/Off next stage

P:38 Outdoor temperature 100% night setback

P:39 Outdoor temperature 0% night setback

P:40 Boost time (minutes)

P:41 Max-boost (°C)

P:42 Pump cut-off (=1)

P:43 Pump exercise (=1)

P:44 Outdoor temperature for pump stop (°C)

- P:45 Supply temperature for pump start
- P:46 Min off time pump (hours)
- P:47 Time format 12/24hour-display
- P:48 Daylight Saving Time 0:no, 1:automatic, 2>manual
- P:49 DST month.day
- P:50 DST time of day
- P:51 Standard time, month.day
- P:52 Standard time, time of day
- P:53 DST adjust (hh:mm)
- P:54 Reset: pressing '+' gives default

Test functions:

- P:60 Program version no.
- P:61 Manual control of output K1
- P:62 Manual control of output K2
- P:63 Manual control of output K3
- P:64 Manual control of output K4
- P:65 Test of all display segments
- P:66 Hysteresis, supply temperature

The operating procedures are described in section 2.4.

4.2 Reset

P:54 Reset

Note!

P:54 is described first, because it may be used to reset all values and to restart the controller. This is an advantage if you are in doubt about the entered values of the controller.

You must be aware of the fact, however, that all the manually entered values will be lost after this restart command, as they are replaced by the factory (default) values. The clock will also be set to zero.

The default values are listed in section 5.3.

The restart is executed when

- the display shows P:54 and you
- press the + key

The *auto* mode will rule with "forced" day time operation, and digital output K4 will be set to zero, until the time is set.

The display will show P:00, with the time flashing 00:00, to indicate that time and date has to be set (section 2.4).

Power failure

At power failure all activities, except the time update, will cease until the power returns.

If the clock running reserve (see chap. 5) is insufficient, the display will show P:00, with the time flashing 00:00, when power has returned. Set the time and date and make a quick check that the remaining entered values have not been affected.

4.3 Control functions

TAC 200 has three separate control functions:

- one controller to limit the power consumption
- one controller for the room temperature
- one controller for the supply water temperature

The controller for the room temperature is used only when there is a room sensor. It is recommended to use a room sensor, as the room temperature controller is very efficient in utilizing the heat stored in the building.

The influence of the outdoor temperature on the supply water temperature is determined by the reset curve. SP_{curve} is modified with SP_{offset} , directly or via the room temperature controller, by the variable Night setback or Morning boost.

If the room temperature controller is active, SP_{offset} will also be affected by the requested setpoint value, the current room temperature and the min/max-limits, if specified.

The resulting value may in turn be reduced by min/max-limits, resulting in the SP value. This value is compared to SP_{powlim} , the maximum allowable setpoint calculated by the power limit controller.

The least of these is used as SP_{supply} for the supply temperature controller.

The pump can be made to turn off at high outdoor temperatures or if SP_{supply} has a low value.

Each of these functions is described in more detail in the following.

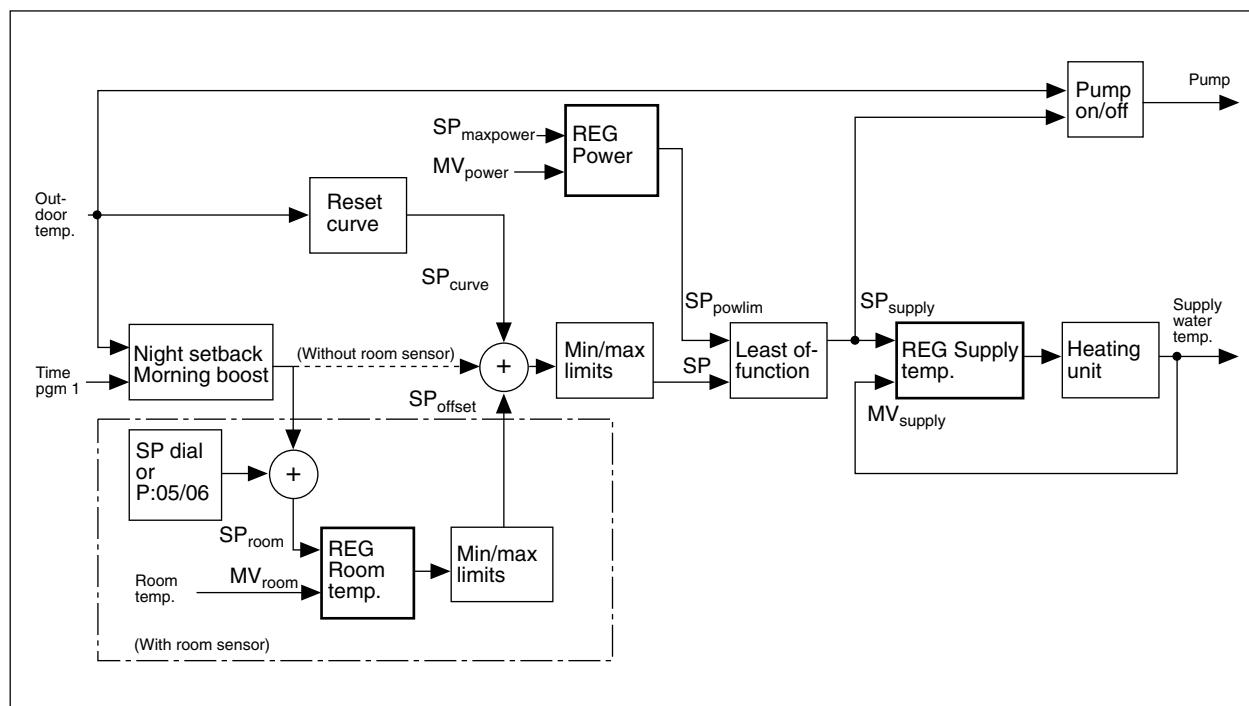

Block diagram for the controllers of the TAC 200.

4.4 The Control curve

The control curve determines the setpoint value (SP) of the supply temperature from the measured outdoor temperature.

There are two different default control curves and by setting the DIP-switch 3, indicating a *radiator* or *floor* heating system, you will get the curve that is best suited for the application.

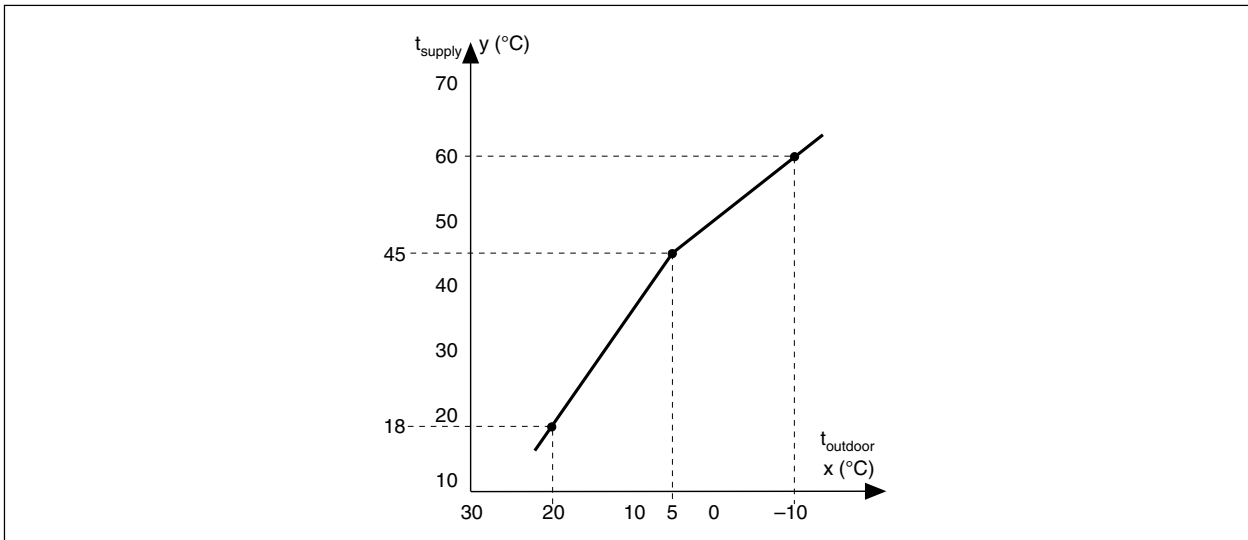

Control curve (default) for a radiator heating system.

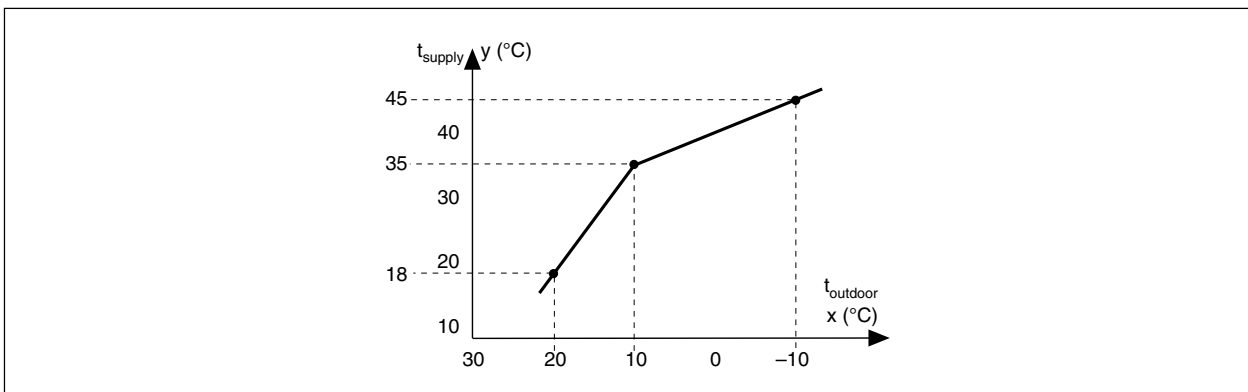

Control curve (default) for a floor heating system.

The control curve is based on three dimension points, defined at the outdoor temperatures -10°C , $+20^{\circ}\text{C}$ and one adjustable temperature between -9°C and $+19^{\circ}\text{C}$.

The corresponding supply temperature of each dimension point is individually adjustable from the display.

The curve inclinations at the end points are used up (down) to selectable maximum and minimum supply temperature limits.

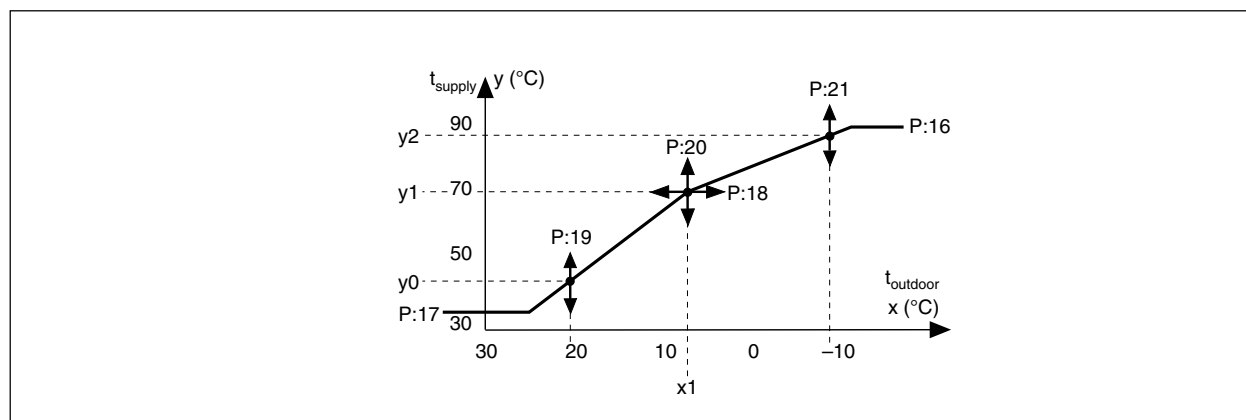

Control curve adjustment.

P:16 Max supply temperature

P:17 Min supply temperature

Adjust the supply temperature values with P:16-17.

P:18 Curve point x(1)

P:19 Curve point y(0)

P:20 Curve point y(1)

P:21 Curve point y(2)

Adjust the control curve with P:18-21.

Note that only one x-coordinate, x_1 (P:18), may be changed, the other two are fixed.

y_0 , y_1 and y_2 are all variable.

The room sensor permits parallel displacement of the control curve (please refer to section 4.6).

If the system is not equipped with a room sensor and there is a constant deviation from the desired room temperature, the control curve may be adjusted upwards or downwards by the function **P:08** (see section 3.2).

4.5 Power limit function

The power consumption may be measured and controlled against a preset high limit.

As shown in the block diagram in 4.3, the power limit controller will limit the setpoint for the supply temperature to keep the power consumption on or below the requested value.



This symbol will flash when the power limiting controller is active.

4.5.1 Measuring the power

Digital input X3 can be used as a pulse counter. If each pulse equals a certain amount of energy, the current power can be calculated and controlled.

P:22 Wh / pulse

or

P:23 Pulses / kWh

are used to specify the energy per pulse. The following table suggests suitable values for some rated power levels.

<i>Wh/pulse (P:22)</i>	<i>Pulses/kWh (P:23)</i>	<i>Rated power, kW</i>
100	10	50 - 500
200	5	800 - 1000
250	4	1000 - 1200
500	2	1000 - 2500
999	1	1000 - 5000

Either P:22 or P:23 may be used, but only the latest entered value is used (and converted to the other representation as well).

P:24 - P:29 will only appear if P:22 is greater than 0.

P:25 Current power kW

The current power consumption, using the P:26 interval, is displayed (but cannot be changed).

4.5.2 Limiting the power

To limit the power consumption the PI controller needs the following parameters.

P:24 Setpoint max-power kW

Required upper value for the power consumption.

P:26 Power limit control interval (minutes)

The controller uses this interval to measure and calculate the current power. The interval must be chosen so that the number of pulses during the interval at the maximum power rate will be 10 or higher. If chosen too short, the accuracy will be insufficient.

P:27 Power limit gain (°C/kW)

The value indicates how much the supply temperature must be lowered in order to lower the power consumption with one kW.

P:28 Power limit I-time (minutes)

The integrating time should have a value similar to the time it takes for a temperature change to affect the room.

4.6 Room temperature control

The room temperature is controlled via the supply water temperature, i.e. the room temperature controller calculates an offset from the outdoor compensated control curve and thus adjusts the supply water setpoint. The controller has proportional (P) and integral (I) action with adjustable parameters.

The supply temperature setpoint (**P:04**) is calculated as the sum of values from the outdoor compensated control curve (with a possible parallel displacement), the morning boost (section 4.7) and the room temperature control offset.

If there is a room sensor, the controller regulates the room temperature with the following parameters, by parallel displacement of the control curve.

P:29 Room sensor authority

P:30 Room I-time (minutes)

P:31 Room deadzone (°C)

The influence of the room temperature on the supply temperature may, however, be limited using the following limit values.

- P:32 Max. room influence, day**
P:33 Max. room influence, night

System without room sensor

If the DIP-switch (section 2.1) indicates that there is no room sensor, then there is no adjustment of the control curve. However, the supply temperature setpoints are parallel displaced when setting the Curve parallel adjustment (**P:08**) to a value not equal to zero.

The supply temperature controller uses these parameters.

- P:34 Supply P-band (°C)**
P:35 Supply I-time (minutes)

The actuator stroke time is set with

- P:36 Actuator stroke time (seconds)**

P:66 Hysteresis at on/off control, supply temperature.

On/off is +/- in °C from curve of stage 1, see the figure below.

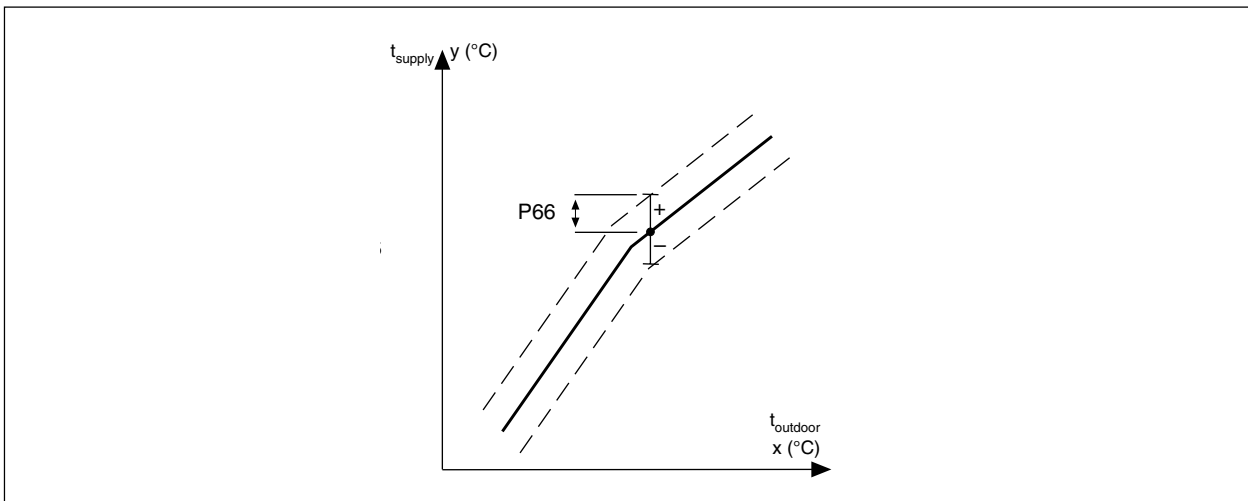

When on/off control is used, the delay time in degree-minutes till the next stage is switched on (or off) is given by

P:37 °C x min On/Off

Ex.: If $P:37=15$ and the control error is 1° , it will take 15 minutes before the next stage is changed ($1^\circ \times 15=15$). If the error is 3° , it will take only 5 minutes ($3^\circ \times 5=15$).

4.7 Night setback and Morning boost

TAC 200 uses a night SP during the night time operation.

The actual SP value depends on several factors.

If there *is* a room sensor, *without* a SP dial, EGRL:

P:06 Setpoint room, night (used as **SP_{room}**)

If there *is* a room sensor, *with* a SP dial, EGF1:

P:07 Night setback SP (affecting the **SP_{room}**)

(A positive value means *raising* the night temperature.)

If there is *no* room sensor:

P:07 Night setback SP (affecting the **SP_{supply}**)

To summarise:

Application	SP _{day}	SP _{night}
EGRL	P:05	P:06
EGF1	SP-dial	SP-dial adjusted with P:07
No sensor	SP _{supply}	SP _{supply} adjusted with P:07

The SP value is also affected by the variable Night setback and the Morning boost.

The Night setback of the supply temperature varies to ensure that the heating system will be able to reach the correct room temperature even after nights with low outdoor temperatures.

The magnitude of the setback is determined via a curve with two variable outdoor temperatures, P:38 and P:39, see figure on the next page.

These two outdoor temperatures are also used to determine the Morning boost. A certain time before time program 1 will indicate Day time operation, the controller boosts the supply temperature.

The boost varies with the outdoor temperatures. It reaches its maximum at the P:38 temperature and is reduced to zero at 20°C and at the P:39 temperature (where there is no longer any night setback), please refer to the figure.

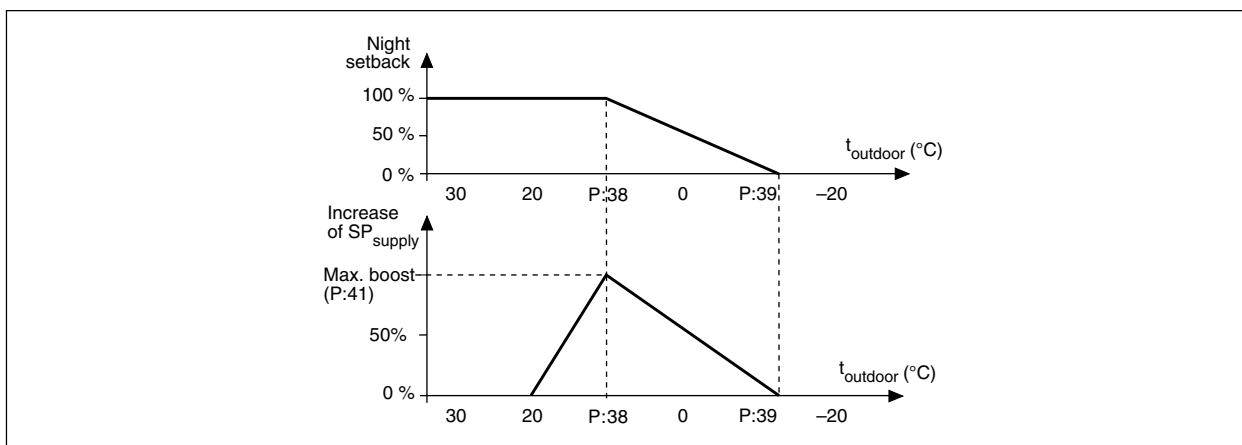

Night setback and Morning boost

The outdoor temperature limits are set with

P:38 Outdoor temperature 100% night setback

(and 100% boost)

P:39 Outdoor temperature 0% night setback

(and 0% boost)

P:38 must always be greater or equal to P:39. If both values are set *equal*, there will always be a full night setback, regardless of the outdoor temperature. Also the morning boost will have its maximum value for all outdoor temperatures below the value P:38 (=P:39).

The boost time (time before Day time) and the amount of boost, in °C, are specified with

P:40 Boost time (minutes)

P:41 Max-boost (°C)

The valid SP is calculated by removing any night setback and adding the boost value determined by the outdoor temperature as shown in the figure.

If P:40 or P:41 is set to zero, the morning boost will be inhibited.

4.8 Extended day/night operation

Day operation is extended if terminal X1 is short-circuited to terminal M, via a switch or a separate timer.

In the same way, night operation is extended if terminal X2 is connected to M.

This type of forced operation is indicated on the display by the flashing appearance of the corresponding symbol. See also the description of P:00 in section 3.2.

4.9 Time control of external units

Time program 2 (section 3.2) may be used to control external units via relay output K4, quite independent of the Day/Night time operation of Time program 1.

For example, switch-over between oil and electrical heating, lighting or fans may be controlled in this way.

Filled segments (P:11, 0-24) indicate an active output.

4.10 Pump control

The pump is operated to utilize the heat stored in the building in the most efficient manner.

The pump is stopped (and the control valve is closed) when:

- the outdoor temperature rises above a preset value.
- the calculated supply temperature falls below a preset "cut-off" limit.

These conditions are set by

P:44 Outdoor temperature for pump stop

P:45 Supply temperature for pump start

Note! This cut-off function is only in operation if

P:42 Pump cut-off

is set to **1**.

The minimum off time after the pump has been stopped is

P:46 Min off time pump (hours)

Once initiated, the period must run out, even if P:46 is changed during this period.

Exercising of pump

The pump is run once a week, provided that

P:43 Pump exercise

is set to **1**. The pump is started at midday each monday and run for one minute to prevent seizure, during stops longer than a week. However, the pump must have stood still for at least a full week, before the pump is exercised.

Anti-freeze protection

The pump will start running to prevent freezing when the outdoor temperature falls below 3°C. This facility cannot be inhibited.

4.11 Time functions

The current time (P:00) may be displayed either in a 24-hour or a 12-hour (AM/PM) format.

P:47 Time format 12/24hour-display

Daylight Saving Time

There are three different ways of treating DST and they are selected by the value of

P:48 Daylight Saving Time 0:no 1:automatic 2>manual

i.e.

- 0** means that standard time will be used the year round.
- 1** means that the controller will automatically switch between DST and standard time. One hour will be added at 2:00 (AM) on the last Sunday of March and taken away again at 3:00 (AM) on the last Sunday of September, each year.
- 2** means that the date and times are determined by the values entered in

P:49 DST month.day

P:50 DST time of day

P:51 Standard time, month.day

P:52 Standard time, time of day

P:53 DST adjust (hh:mm)

For example, to add 1:30 hours at 02:00 on the 28th of March and remove the same amount at 03:30 on the 31st of October, enter

P:49 03.28

P:50 02:00

P:51 10.31

P:52 03:30

P:53 01:30

4.12 Test functions

There are a number of test functions to check the display, the relay outputs etc.

To see what program version is loaded, use

P:60 Program version no. x.xx

The current version of the program is shown on the display.

The four relay outputs can be controlled directly from the panel (+ : on, - : off) when the following functions are used.

P:61 Manual control of output K1

P:62 Manual control of output K2

P:63 Manual control of output K3

P:64 Manual control of output K4

The requested output is shown on the display: 1 : on, 0 : off.

Note!

The manual control is only in action as long as the controller is in actual position. If the key (on (+) or off (-)) has not been touched for more than 2 minutes the display return to 00 and the controller takes normal control of the output again.

With the function

P:65 Test the display

you can turn on (+) and off (-) all the segments of the display.

5 Technical data

5.1 Electrical

Supply voltage 220-230 V AC $\pm 10\%$, 50-60Hz
 Power consumption 2 VA

Ambient temperature

Operation $\pm 0^\circ$ to $+50^\circ\text{C}$
 Storage -20° to $+50^\circ\text{C}$
 Ambient humidity max 90 % RH

Real time clock accuracy at 25°C ± 12 minutes per year
 Power off, clock and memory protection max 12 hours

Control function PI
 Application select DIP-switch with 8 switches

Digital inputs:

Quantity 3
 Voltage over open input max. 33 V
 Current through closed input ~ 5 mA
 Pulse input duration min. 50 ms
 Pulse cycle duration min. 100 ms

Analog inputs:

Quantity 3
 Characteristics NTC 1.8 kohm at $+25^\circ\text{C}$
 Measuring range:
 Outdoor temperature, EGU -30° to $+40^\circ\text{C}$
 Supply temperature, EGWS/EGA 0° to $+120^\circ\text{C}$
 Room sensor, EGRL/EGF 1 $+5^\circ$ to $+35^\circ\text{C}$

Relay outputs:

Quantity 4
 Function closing contact
 Voltage max 250 V AC
 Current 2A
 min 50 mA at 24 V

Agency compliances

Radiation EN 50081-1
 Immunity EN 50082-1

5.2 Mechanical

Enclosure	ABS-plastic
Enclosure rating	IP 40
Colour	black/transparent
Weight	0.7 kg
Dimensions (WxHxD)	144 x 96 x 94mm
	when mounted in panel (panel cutout 138 x 92 mm, DIN 43 700)
	22 mm will protrude, while max. 72 mm will lie behind the panel.

5.3 Default values

Listed below are the default values, used at P:54 Restart.

P-functions in italics show display-only values.

P:	Meaning	Default value
P:00	Time / Mode	00:00 /Auto, with Day time op.
P:01	Room temperature	-
P:02	Outdoor temperature	-
P:03	Supply temperature	-
P:04	Calculated supply temperature setpoint (SP)-	
P:05	SetPoint room, day	21
P:06	SetPoint room, night	18
P:07	Night setback SP (°C)	-10 (no room sensor: supply temp.) -2 (room sensor EGF 1: room temp.)
P:08	Curve parallel adjustment	0
P:09	Time program 1, day-by-day	Day time operation 06:00 - 22:00
P:10	Time program 1, 1-7 days	Monday through Sunday
P:11	Time program 2, day-by-day	00:00 - 00:00
P:12	Time program 2, 1-7 days	None
P:13	Clock hh:mm	00:00
P:14	Month.day	01.01
P:15	Year	1995
P:16	Max supply temperature	80 (radiator) / 55 (floor heating)
P:17	Min supply temperature	10 (radiator) / 10 (floor heating)
P:18	Curve point x(1)	5 (radiator) / 10 (floor heating)
P:19	Curve point y(0)	18
P:20	Curve point y(1)	45 (radiator) / 35 (floor heating)
P:21	Curve point y(2)	60 (radiator) / 45 (floor heating)
P:22	Wh / pulse	0.0 (inverted value x 1000 of P:23)
P:23	Pulses / kWh	999.0 (inverted value x 1000 of P:22)
P:24	SP max-power kW	999
P:25	Current power kW	-

P:	Meaning	Default value
P:26	Power limit control interval (minutes)	10
P:27	Power limit gain (°C/kW)	1
P:28	Power limit I-time (minutes)	10
P:29	Room sensor authority	10
P:30	Room I-time (minutes)	60
P:31	Room deadzone (°C)	0.3
P:32	Max. room influence, day	10°
P:33	Max. room influence, night	30°
P:34	Supply P-band (°C)	100
P:35	Supply I-time (minutes)	4
P:36	Actuator stroke time (seconds)	170 (corresponding to 90° for M44)
P:37	°C x min On/Off	15
P:38	Outdoor temperature 100% night setback	10
P:39	Outdoor temperature 0% night setback	-10
P:40	Boost time (minutes)	120
P:41	Max-boost (°C)	5
P:42	Pump cut-off (=1)	1 cut-off active
P:43	Pump exercise (=1)	1 pump exercised once a week
P:44	Outdoor temperature for pump stop	20 (if P:42=1)
P:45	Supply temperature for pump start	20 (if P:42=1)
P:46	Min off time pump (hours)	2 (if P:42=1)
P:47	Time format 12/24hour-display	24
P:48	DST 0:no 1:automatic 2>manual	1 DST autom. implemented
P:49	DST month.day	03.31 (if P:48=2, i.e. manual)
P:50	DST time of day	02:00 (if P:48=2)
P:51	Standard time, month.day	09.30 (if P:48=2)
P:52	Standard time, time of day	03:00 (if P:48=2)
P:53	DST adjust (hh:mm)	01:00 (if P:48=2)
P:54	Reset: pressing '+' gives default	-
P:60	Program version	x.xx
P:61	Manual control of output K1 +:on -:off	1/0 (on/off)
P:62	Manual control of output K2 +:on -:off	1/0 (on/off)
P:63	Manual control of output K3 +:on -:off	1/0 (on/off)
P:64	Manual control of output K4 +:on -:off	1/0 (on/off)
P:65	Test of all the display segments +:on -:off	- :off (on/off)
P:66	Hysteresis, supply temperature (C°)	3.0 (if on/off)

5.4 Part numbers

Article	Part number
TAC 200 with normal back cover	200-1000-000
TAC 200, without back cover	200-100x-000
Back cover, extended	200-100x-000



TAC 200 Commissioning protocol

Enter the new values here!

Configuration	Switch	Function pos off	Function pos on
	1	on/off control	shunt valve
	2	on/off: 2 steps	on/off: 3 steps
	3	radiator heating	floor heating
	4	no sensor/thermostat	room sensor or thermostat
	5	room sensor EGRL	room thermostat EGF1
Setpoints	Default value	New value	Remarks
P:05 SP room, day	21		(if room sensor)
P:06 SP room, night	18		(if room sensor)
P:07 Night setback SP (°C)	-10 / -2		Without/with room thermostat EGF1
P:08 Curve parallel adjustment	0		

Time program 1	P:09, P10	MO	TU	WE	TH	FR	SA	SU
Day operation	from							
	to							
	from							
	to							

Time program 2	P:11, P12	MO	TU	WE	TH	FR	SA	SU
Day operation	from							
	to							
	from							
	to							

Control curve	Default value	New value	Remarks
P:16 Max supply temperature	80 / 55		radiator / floor heating
P:17 Min supply temperature	10/10		
P:18 Curve point x 1	5 / 10		radiator / floor heating; -9 - +19
P:19 Curve point y 0	18		
P:20 Curve point y 1	45 / 35		radiator / floor heating
P:21 Curve point y 2	60 / 45		radiator / floor heating

P.T.O

Date	Commissioned by	Designation
Situated at		Order no.
Remarks		Drawing no.

Power limiting	Default value	New value	Remarks
P:22 Wh / pulse	0.0		(also calculated from P:23)
P:23 Pulses / kWh	999.0		(also calculated from P:22)
P:24 SP max power kW	999		(if P:22 is greater than 0)
P:25 Current power kW	-		
P:26 Power lim cntrl intvl (mins.)	10		(if P:22 is greater than 0)
P:27 Power limit gain (°C/kW)	1		(if P:22 is greater than 0)
P:28 Power limit l-time (mins.)	10		(if P:22 is greater than 0)

Zone control	Default value	New value	Remarks
P:29 Room sensor authority	10		(if room sensor)
P:30 Room l-time (mins.)	60		(if room sensor)
P:31 Room deadzone (°C)	0.3		(if room sensor)
P:32 Max. room infl. day (°K)	10		(if room sensor)
P:33 Max. room infl. night (°K)	30		(if room sensor)

Supply temp. control	Default value	New value	Remarks
P:34 Supply P-band (°C)	100		(if mixing valve)
P:35 Supply l-time (mins.)	4		(if mixing valve)
P:36 Actuator stroke time (secs.)	170		(if mixing valve)
P:37 °C x min On/Off	15		(if on/off control)
P:66 Hysteresis (°C)	3.0		(if on/off control)

Night setback/Morning boost	Default value	New value	Remarks
P:38 Out temp. 100% night setb.	10		also applies to 100% boost
P:39 Out temp. 0% night setb.	-10		also applies to 100% boost
P:40 Boost time (mins.)	120		
P:41 Max-boost (°C)	5		(if P:40 is greater than 0)

Pump control	Default value	New value	Remarks
P:42 Pump cut-off (=1)	1		cut-off active
P:43 Pump exercise (=1)	1		(if P:42=1) pump exercise once a week
P:44 Outd. temp for pump stop	20		(if P:42 = 1)
P:45 Suppl. temp for pump start	20		(if P:42 = 1)
P:46 Min off time pump (hours)	2		(if P:42 = 1)

Time control	Default value	New value	Remarks
P:47 Time fmt 12/24h-display	24		12 or 24
P:48 DST 0:no 1:auto 2>manual	1		1 = DST autom. implemented
P:49 DST month.day	03.31		(if P:48 = 2, i e manual)
P:50 DST time of day	2:00		(if P:48 = 2)
P:51 Standard time, month.day	09,30		(if P:48 = 2)
P:52 Standard time, time of day	3:00		(if P:48 = 2)
P:53 DST adjust (hh:mm)	1:00		(if P:48 = 2)

You can help make this manual even better!

Please help us make our documentation as user-friendly as possible. Use this form to let us know of any errors, unclear descriptions or suggested improvements.

Send the form to:
TAC AB
Technical Centre
Jägershillgatan 18
S-213 75 MALMÖ
Sweden

I have found the following errors and/or unclear descriptions in the
"TAC 200 User's Manual" (Article no. 0-004-1201 (GB)):

On page:
.....
.....

On page:
.....
.....

On page:
.....
.....

I suggest the following improvements:

On page:
.....
.....

On page:
.....
.....

Name:

Company:



TAC AB, Jägershillgatan 18, SE-213 75 MALMÖ, SWEDEN, +46 40 38 68 50 (vx)
